

EUROPE

SERIES 3

Heavy gauge spun aluminum shade

Die-cast dome top and ballast enclosure

Pole and wall mount options

Compact fluorescent or HID sources

Decorative options

CHOICE OF OPTICAL SYSTEMS

Segmented optics

Clear glass

Cast lamp guards

Tear drop enclosures

Glass refractors

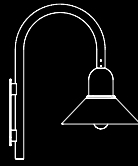

EUROPE

SERIES 3

DIMENSIONS

SMALL

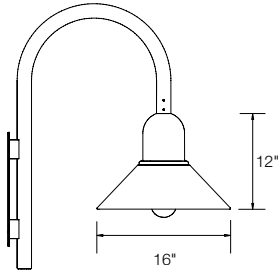

LARGE

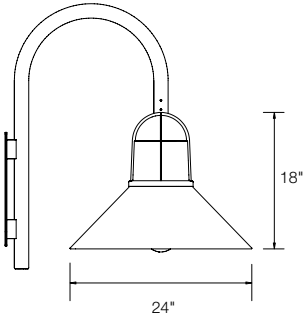

OPTICS

CFL

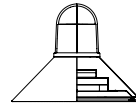

CGG / DAR

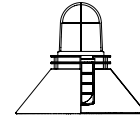

CGJ

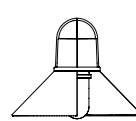

SPECIFICATIONS

SIZES

Small = 16"/19" diameter
Large = 24" diameter

MOUNTING

Pole mount
Pendant
Wall mount

COLOR

Textured or smooth polyester powder coat finishes
RAL colors available

BALLASTS

Compact fluorescent = HPF electronic
HID = HPF magnetic

OPTIONS

Photocell

OPTICS

See technical sheets for details

MAXIMUM LAMP TYPE*

	SMALL	LARGE
Incandescent	100 watts	200 watts
Compact fluorescent	32 watts	42 watts
High pressure sodium	50 watts	150 watts
Metal halide	50 watts	175 watts

* Consult technical sheets for specific lamp application

LISTINGS



Wet location luminaire



Listed to applicable CSA and UL standards

ADDITIONAL STYLES



EUROPE - Series 3

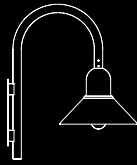

EUROPE

Series 3

STANDARD FEATURES

- Heavy gauge spun aluminum shade
- Die-cast dome top and ballast enclosure
- Choice of optical systems
 - Segmented optics with clear flat glass lens
 - Clear glass and cast guard lamp enclosures with optional louvers
 - Large clear "tear drop" lamp enclosures with optional louvers or glass refractors
- Pole and wall mount options
- Incandescent, compact fluorescent and HID sources
- A selection of optional annular rings and translucent collars

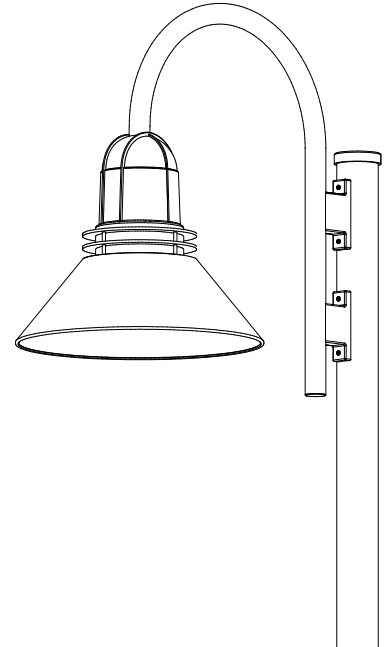

Wet location luminaire



Listed to applicable CSA and UL standards

ORDERING CODE GUIDE

SERIES	MODEL	SIZE	LAMP	OPTICS	VOLT	MOUNTING ①	RING	COLLAR ④	COLOR	OPTIONS
EURO 3	4050									
		16"	INC100 PLC13 PLC18 PLC26 PLT32 35HPS 50HPS 50MH	O = no optics CGJ = clear glass jar no optics CGG= clear glass jar & guard no optics CLF= clear flat lens & segmented	120 277 347	SHK = shepherd's hook WAM = wall arm mount PM = pendant mount Consult factory for additional mounting	NR = no ring ② SAR = single aluminum ring DAR = double aluminum ring	OP = opal polycarbonate CP = clear polycarbonate FP = frosted polycarbonate	<u>TEXTURED FINISHES</u> TAL = textured aluminum TBK = textured black TBZ = textured bronze TWH = textured white <u>SMOOTH FINISHES</u> AL = silverdillo BK = black BY = buttercup yellow DBZ = dark bronze DO = deep orange EG = emerald green RB = royal blue RR = rich red WH = white RAL colors available	Photocell factory installed PE1 = 120 volt PE2 = 277 volt
		24"	INC150 INC200 PLT42 100HPS 150HPS 100MH 175MH	II, III, IV, V ③ CTD=clear tear drop lens & glass refractor III, V ④ Louvers = SL/B, SL/F ⑤						

Notes:

- ① See reverse for technical mounting details
- ② No collar needed
- ③ Comes with 19" shade for small
- ④ N/A for small 16"
- ⑤ Available only with glass enclosures

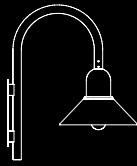

EUROPE

Series 3

DIMENSIONS

Small / EPA = 1.1

Large / EPA = 1.65

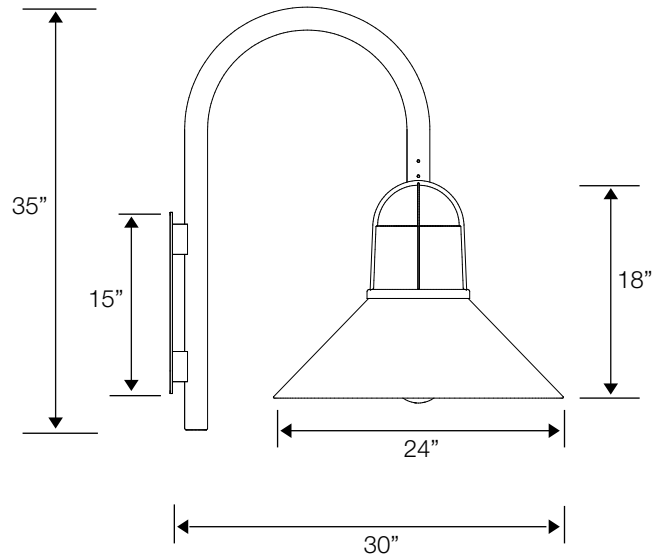
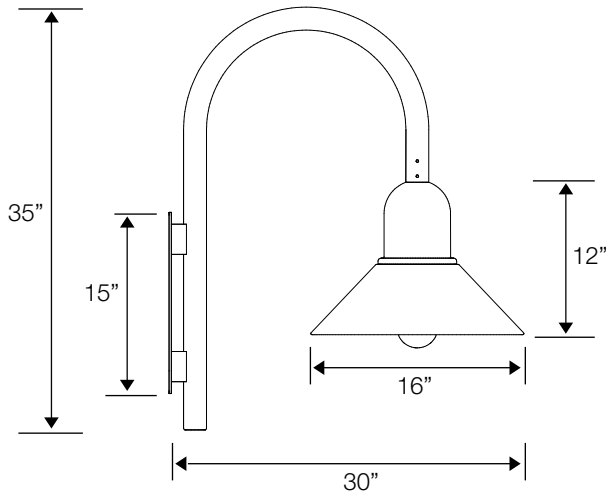

CGJ = Clear glass jar

CGG/DAR = clear glass jar & guard

CFL = clear flat lens & segmented reflector (II, III, IV, V)

SL/F

Type III or V

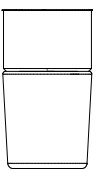
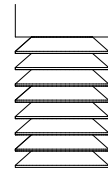
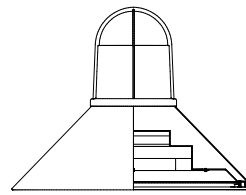
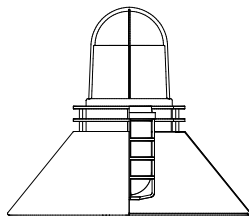
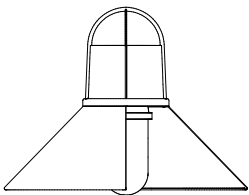

Mounting

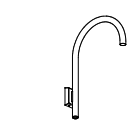

WM-SHK1



WAM

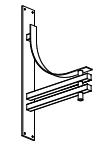

DWA-1



DWA-2

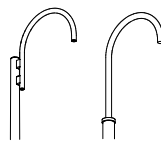

PT-SHK1



PT-SHK2

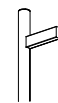

PAM

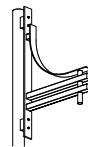

DPA-1