

# ROBUSTO

## AESW - Shaped Wedge

Architectural shaped wedge

.....  
Heavy gauge formed aluminum construction

.....  
Clear tempered glass lens standard

.....  
Optional prismatic lens available

.....  
High performance specular optical systems

.....  
Optional pole and bollard mounting

# ROBUSTO

AESW - Shaped Wedge

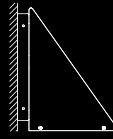

## DIMENSIONS

### WALL MOUNT

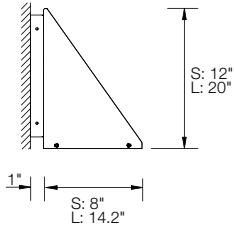

### YOKE MOUNT

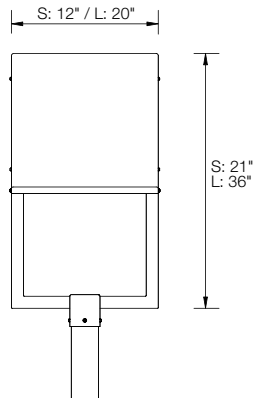

### BOLLARD

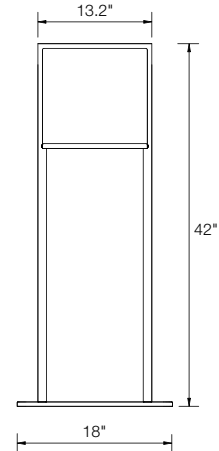

## SPECIFICATIONS

### SIZES

Small  
Large

### MOUNTING

Wall Mount, bollard, yoke mount  
See technical data sheets for other mounting

### COLOR

Textured polyester powder coat finishes

### BALLASTS

Compact fluorescent = HPF Electronic  
HID = HPF Magnetic

### OPTICS

Narrow spot  
Wall wash  
Forward flood  
See technical data sheets for details

### MAXIMUM LAMP TYPE\*

	SMALL	LARGE
Incandescent	150 watts	250 watts
Compact fluorescent	42 watts	4x42 watts
High pressure sodium	150 watts	400 watts
Metal halide	150 watts	400 watts

\* Consult technical data sheets for specific lamp application

### LISTINGS



Wet location luminaire

## ADDITIONAL STYLES



AEDC - Demi-Cylinder



AERW - Rectangular Wedge



AEQS - Quarter Sphere



Listed to applicable CSA and UL standards

# ROBUSTO

## AESW - Shaped Wedge

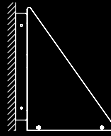

### STANDARD FEATURES

- Architectural shape wedge
- Heavy gauge formed aluminum construction
- Extruded aluminum lens doorframe
- Clear tempered glass lens standard
- Optional prismatic lens available
- High performance specular optical systems
- Optional yoke and bollard mounting available
- HPF ballast, magnetic for HID and low THD electronic for PL
- Suitable for up or downlight

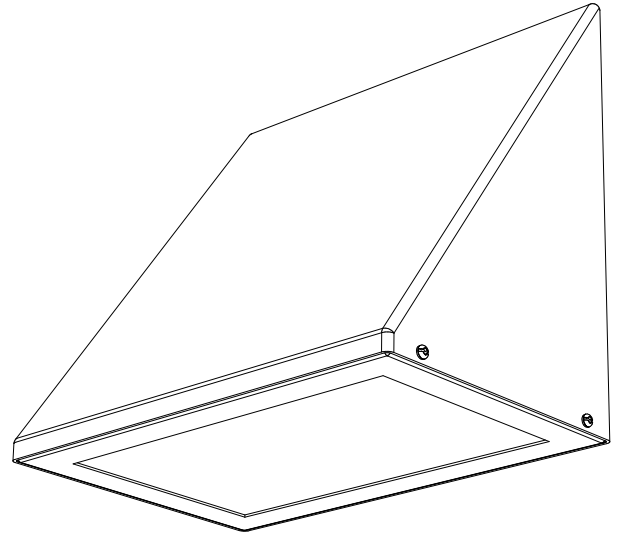

Wet location luminaire



Listed to applicable CSA and UL standards

### ORDERING CODE GUIDE

SERIES	MODEL	SIZE	LAMP	VOLT ②	OPTICS ①	COLOR	MOUNTING	OPTIONS
AESW	1620	S = small	PLC13 PLC18 PLC26 PLT32 PLT42 35HPS 50HPS 70HPS 100HPS 50MH 70MH 100MH	120 277 347	NS = narrow spot WW = wall wash FF = forward flood	<u>TEXTURED FINISHES</u> TAL = textured aluminum TBK = textured black TBZ = textured bronze TWH = textured white	WMDL = wall mount, downlight WMUL = wall mount, uplight YM = yoke mount 2YM = 2 yoke mount BM/S = bollard mount, single BM/D = bollard mount, double PM = pole mount	PGL = prismatic glass lens Photo cell factory installed PE1 = 120 volt PE2 = 277 volt
	1640	L = large	150HPS 200HPS 250HPS 400HPS 175MH 250MH 400MH					

Notes:

- ① Applicable with clear glass lens only
- ② Not all voltages are available for all lamp types, please consult factory

# ROBUSTO

AESW - Shaped Wedge

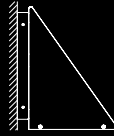

## DIMENSIONS

WMDL = wall mount downlight

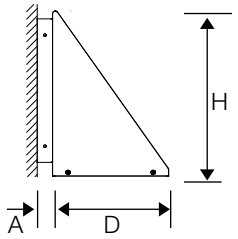

WMUL = wall mount uplight

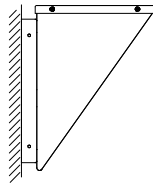

PM = Pole Mount

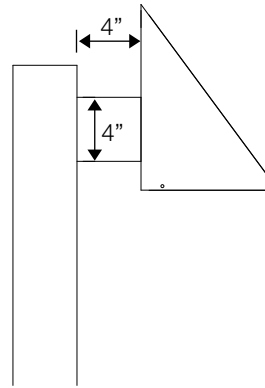

BM/S = bollard single

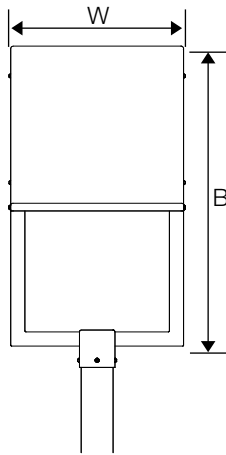
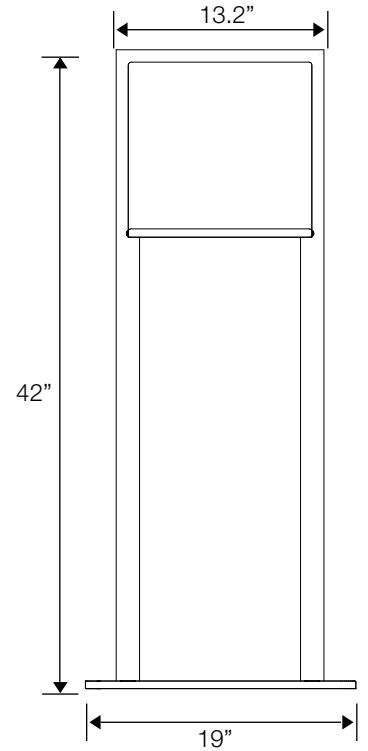

YM = yoke mount

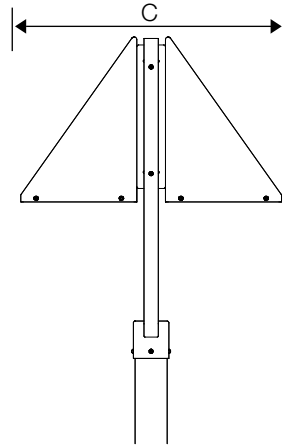

2YM = 2 yoke mount

Bollard base detail

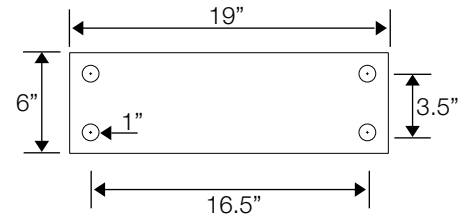

	W	H	D	A	B	C	EPA
Small	12"	12"	8"	1.0"	21.0"	18.3"	1.8
Large	20.0"	20.0"	14.2"	1.5"	36.0"	32.0"	2.3