

SLOOP

ASFL-Wall Mount

Die-cast aluminum housing in two sizes

Die-cast hinged and gasketed lens frame

Specular aluminum forward throw reflector

Clear tempered glass lens

APPLICATIONS

- Direct and indirect lighting
- Flood lighting
- Building highlighting
- Wall washing

SLOOP

ASFL-Wall Mount

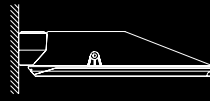

DIMENSIONS

SMALL

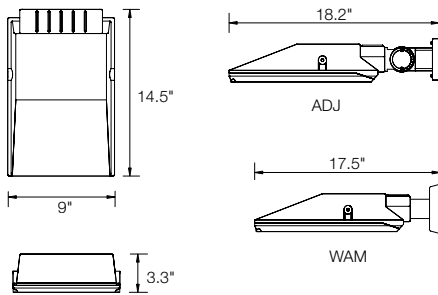

IP65 Rated

LARGE

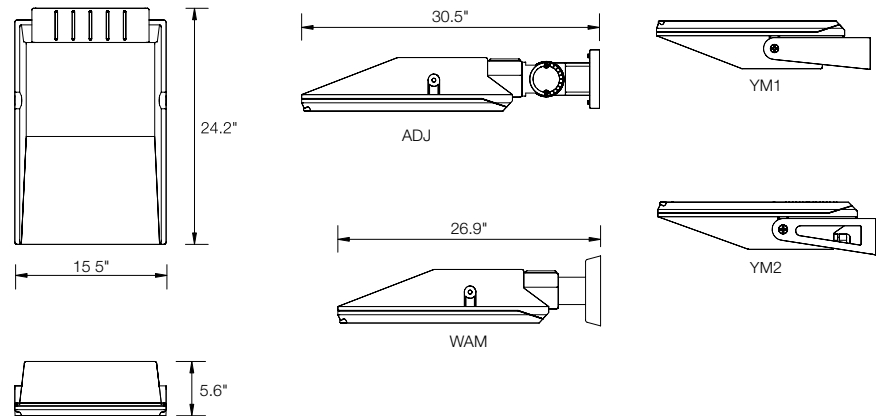

SPECIFICATIONS

SIZES

Small = 9" x 14.5"
Large = 15.5" x 24.2"

MOUNTING

Flush wall mount
Die cast splice and mounting box
Available in 2 standard yoke mounts - see below

COLOR

Textured or smooth polyester powder coat finishes
RAL colors available

BALLASTS

Compact fluorescent = HPF Electronic
HID = HPF magnetic

OPTIONS

Photocell

OPTICS

Forward flood standard
Consult technical sheets for other optical options

MAXIMUM LAMP TYPE*

	SMALL	LARGE
Incandescent	C/F	C/F
Compact fluorescent	C/F	C/F
High pressure sodium	100 watts	400 watts
Metal halide	100 watts	400 watts

* Consult technical sheets for specific lamp applications

LISTINGS



Wet location luminaire



Listed to applicable CSA and UL standards

ADDITIONAL STYLES



Post Mount



Yoke Mount



Flush Mount

SLOOP

ASFL - Wall Mount

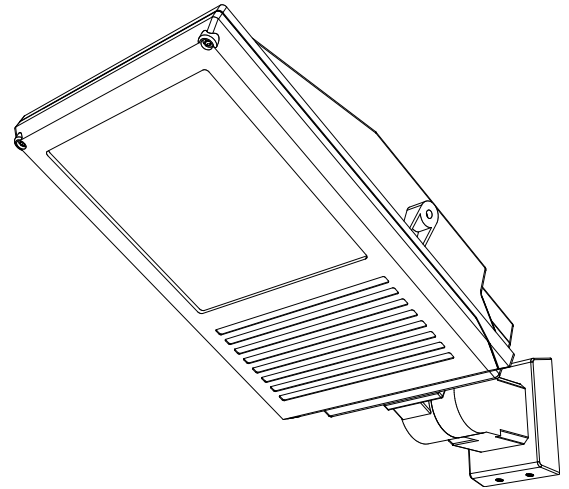
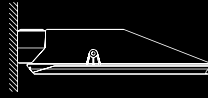

STANDARD FEATURES

- Die-cast aluminum housing in two sizes
- Die-cast hinged and gasketed lens frame
- Specular aluminum forward throw reflector standard
- Optional optics available
- Clear tempered glass lens
- Two laser cut aluminum yoke mount options

IP65 Rated



Wet location luminaire



Listed to applicable CSA and UL standards

ORDERING CODE GUIDE

SERIES	MODEL	SIZE	LAMP	VOLT	OPTICS	COLOR	MOUNTING	OPTIONS
ASFL	1650							
		S = small	35HPS 50HPS 70HPS 100HPS 50MH 70MH 100MH	120 277 347	FF = forward flood WW = wall wash	<u>TEXTURED FINISHES</u> TAL = textured aluminum TBK = textured black TBZ = textured bronze TWH = textured white	YM1 = yoke mount YM2 = yoke mount FM = flush mount WAM = wall arm mount ADJ = adjustable arm mount	Photo cell factory installed PE1 = 120V ❶ PE2 = 277V ❶
		L = large	150HPS 200HPS 250HPS 400HPS 150MH 175MH 250MH 400MH ❶		2 = Type II 3 = Type III FF = forward flood WW = wall wash	<u>SMOOTH FINISHES</u> AL = silverdillo BK = black BY = buttercup yellow DBZ = dark bronze DO = deep orange EG = emerald green RB = royal blue RR = rich red WH = white RAL colors available		

Notes:

- ❶ Not available in yoke mount (YM) or flush mount (FM)

SLOOP

ASFL - Wall Mount

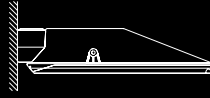

DIMENSIONS

ADJ

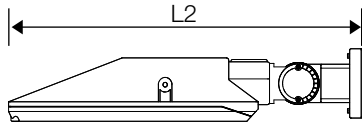

SMALL

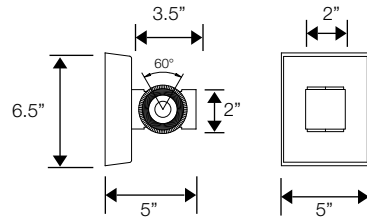

LARGE

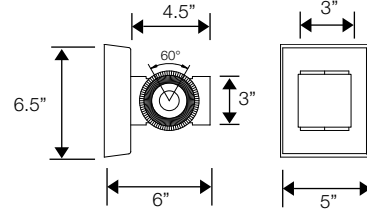

WAM

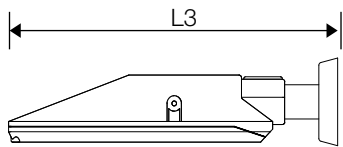

SMALL

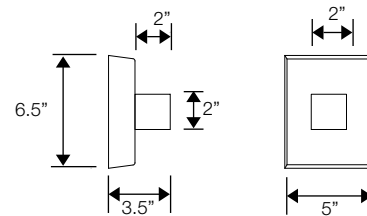

LARGE

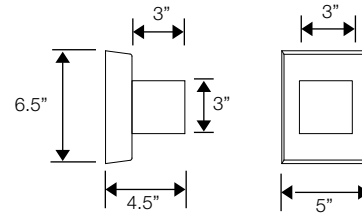

Mounting Bracket YM - Small

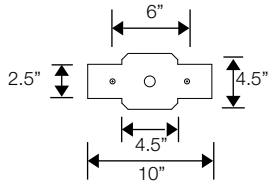

Mounting Bracket YM - Large

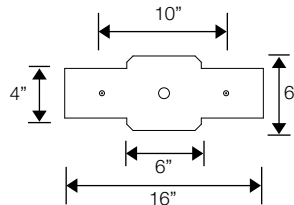

YM1

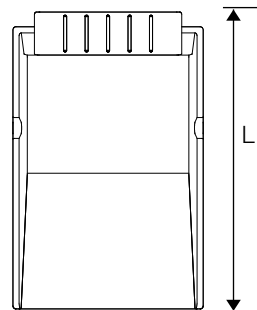
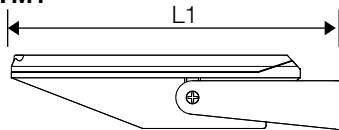

YM2

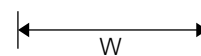
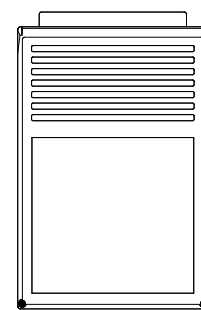
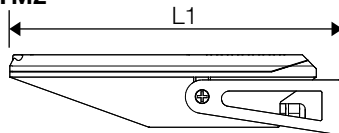

Flush Mount

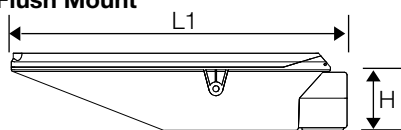

	W	H	L	L1	L2	L3
Small	9"	3.3"	14.5"	15.0"	19.5"	18"
Large	15.5"	5.6"	24.2"	25.3"	30.5"	28.3"